

GND-3621Ax-Bx (DUAL DIGIT LED DISPLAY)

GND-3621 Series

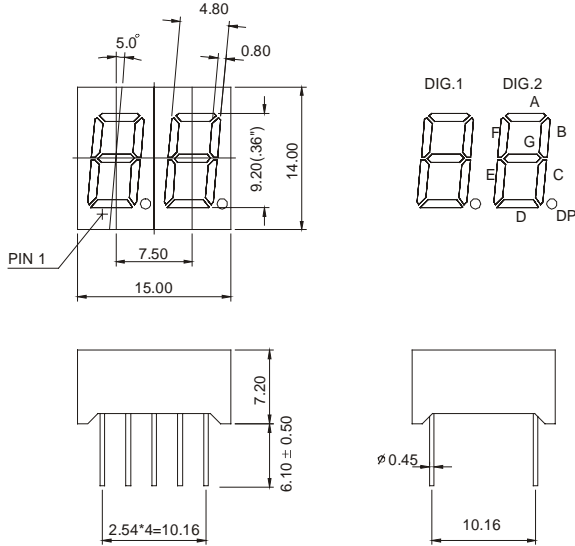

GND-3621Ax

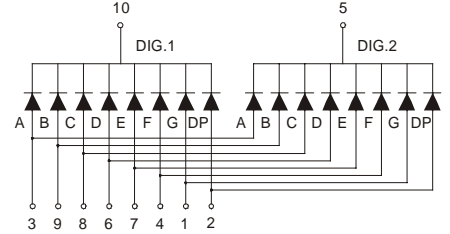

GND-3621Bx

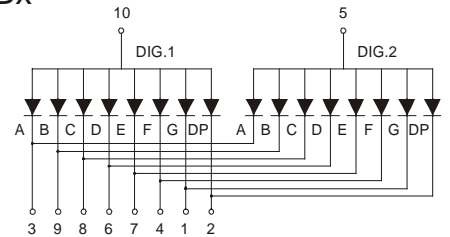

Features:

*0.36 INCH HIGH CHARACTER.

*EXCELLENT CHARACTER APPEARANCE.

*COMMON CATHODE OR COMMON ANODE.

*I.C. COMPATIBLE.

*LOW POWER CONSUMPTION.

Part Number	EMITTED COLOR		Common Cathode or Common Anode	Peak Wavelength (nm)	Vf (v) Typ	If (mA)	Intensity Per Segment (mcd)	
							Min.	Typ.
GND-3621AE	GaAsP/GaP	Hi.effi Red	Common Cathode	635	2.0	20	9	12
GND-3621AG	GaP	Green		565	2.1	20	8	11
GND-3621AY	GaAsP/GaP	Yellow		585	2.0	20	9	12
GND-3621AS	GaAlAs	Super Red		660	1.8	20	10	13
GND-3621AD	GaAlAs	Ultra Red		660	1.8	20	25	30
GND-3621AUE	AlGaInP	Ultra Red		625	2.0	20	30	35
GND-3621AUJ	AlGaInP	Ultra Yellow		590	2.0	20	30	35
GND-3621BE	GaAsP/GaP	Hi.effi Red	Common Anode	635	2.0	20	9	12
GND-3621BG	GaP	Green		565	2.1	20	8	11
GND-3621BY	GaAsP/GaP	Yellow		585	2.0	20	9	12
GND-3621BS	GaAlAs	Super Red		660	1.8	20	10	13
GND-3621BD	GaAlAs	Ultra Red		660	1.8	20	25	30
GND-3621BUE	AlGaInP	Ultra Red		625	2.0	20	30	35
GND-3621BUY	AlGaInP	Ultra Yellow		590	2.0	20	30	35