

| REV. | DESCRIPTION | DRAWN | CHECKED | APPROVED |
|------|-------------|---------------|---------|---------------|
| A | NEW RELEASE | LJH 03/30/06' | ~ | LJC 03/30/06' |
| B | 整理图纸 | YCH 10/18/10' | ~ | |
| | | | | |

NOTES:

- ELECTRICAL CHARACTERISTICS:
 - CONTACT RESISTANCE: 20mΩ Max. INITIAL.
 - DIELECTRIC WITHSTANDING VOLTAGE: 500V AC(rms) FOR 1 MINUTE.
 - INSULATION RESISTANCE: 1000MΩ Min.
- ENVIRONMENT CHARACTERISTICS:
 - OPERATING TEMPERATURE: 0°C~+85°C.
 - STORAGE TEMPERATURE: -20°C~+70°C.
- PART NUMBER: DS1004
- PRODUCT NUMBER CODE:

DS1004 - X X X

- CONTACT TYPE
1: TYPE 1 3: TYPE 3
2: TYPE 2 4: TYPE 4
- CONTACT PLATING
F1: Full GOLD FLASH
- No.OF CONTACTS
1*1 - 1*40
2*1 - 2*40

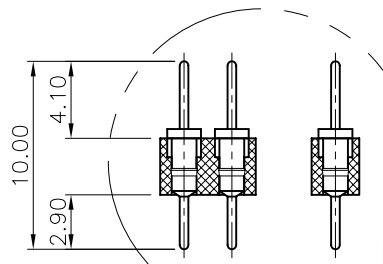

TYPE 1

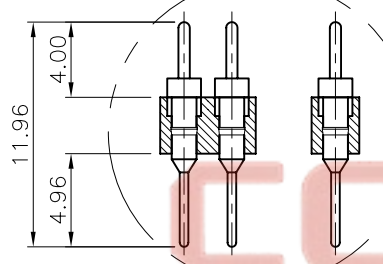

TYPE 2

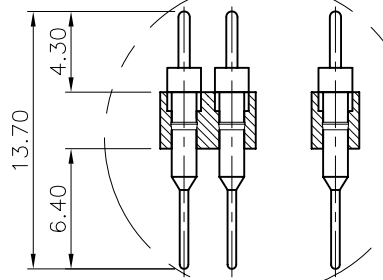

TYPE 3

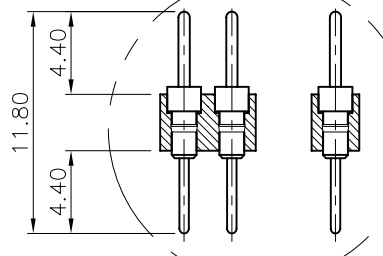

TYPE 4

DUAL ROW SINGLE ROW

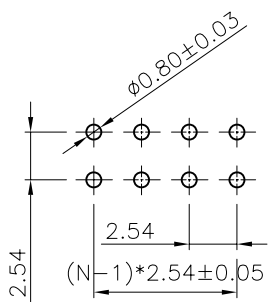

RECOMMEND PCB LAYOUT (TOLERANCE=±0.05)

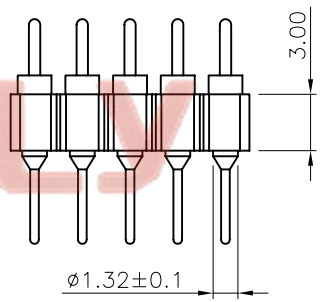
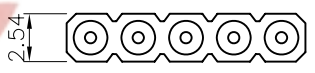
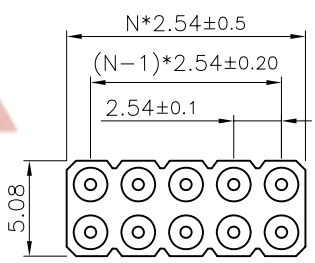

TYPE1/2/3/4 DIA. (TOLERANCE=±0.05)

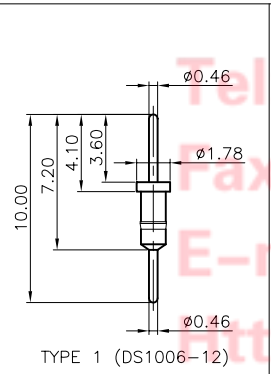

TYPE 1 (DS1006-12)

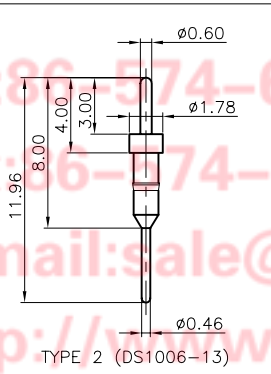

TYPE 2 (DS1006-13)

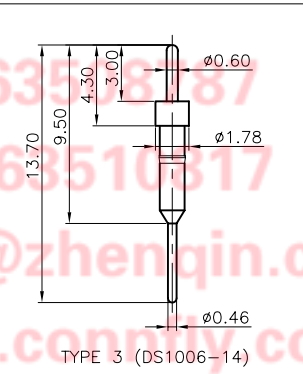

TYPE 3 (DS1006-14)

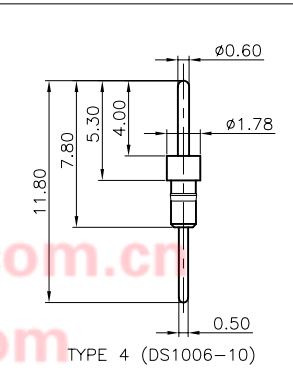

TYPE 4 (DS1006-10)

| | | | | | | |
|-------------------|--------------|-----------------|------|---|--------------------------------|---------------|
| GENERAL TOLERANCE | | ANGLE TOLERANCE | | PROJECTION | TITLE | |
| X. | ±0.60 | X. | ±5° | mm | DIP STRIP ADAPTER PITCH 2.54mm | |
| .X | ±0.38 | .X | ±3° | A4 | SERIES | DS1004 SERIES |
| .XX | ±0.25 | .XX | ±2° | | | |
| DRAWING TYPE | | CUSTOMER | | 晨翔电子有限公司 CONNFLY CONNFLY ELECTRONIC CO. LTD | | |
| SCALE | 1:1 | SHEET | 10F1 | | | |
| DRAWING NO. | C-DS1004-XXX | | | | | |