

REV.	DESCRIPTION OF MODIFY	DATE
A	First Drawing	2007.11.21
B	Add Pintable	2007.11.24
C	Remove Null Pin 19	2007.11.26

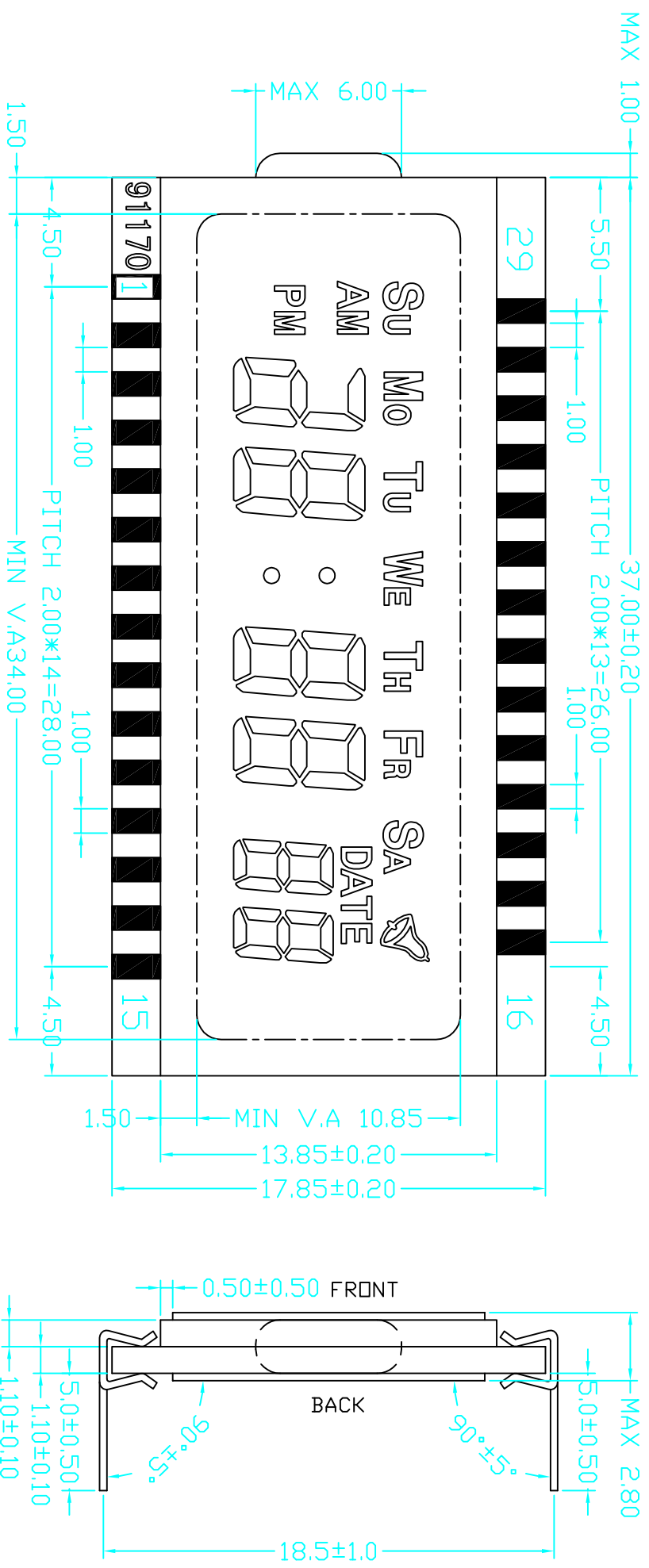

NOTE:

1. DISPLAY TYPE: TN & POSITIVE
2. POLARIZER MODE: REFLECTIVE
3. VIEWING DIRECTION: 6 D/CLOCK
4. OPERATING VOL TAG: 3.0 V
5. DRIVE METHOD: 1/2 DUTY, 1/2 BIAS
6. OPERATING TEMP: 0°C TD +50°C
7. STORAGE TEMP: -10°C TD +60°C
8. CONNECTOR: PIN
9. CUSTOMER No.: TP093

DRAWN BY :		WINCOM	
CHECKED BY :		WINCOM TECH CO.,LTD	
TEL: (0755)26154265		DWG NO. : TP093	
FAX: (0755)83308659		REV: A	
jjangyao@wincomlcd.com		SHEET: 1/3	
		SCALE:	
		UNITS: MM	
		TITL	

REV.	DESCRIPTION OF MODIFY	DATE
A	First Drawing	2007.11.21
B	Add Pintable	2007.11.24
C	Remove Null Pin 19	2007.11.26

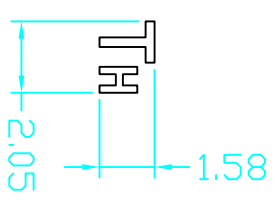
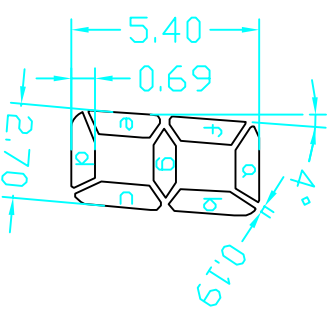
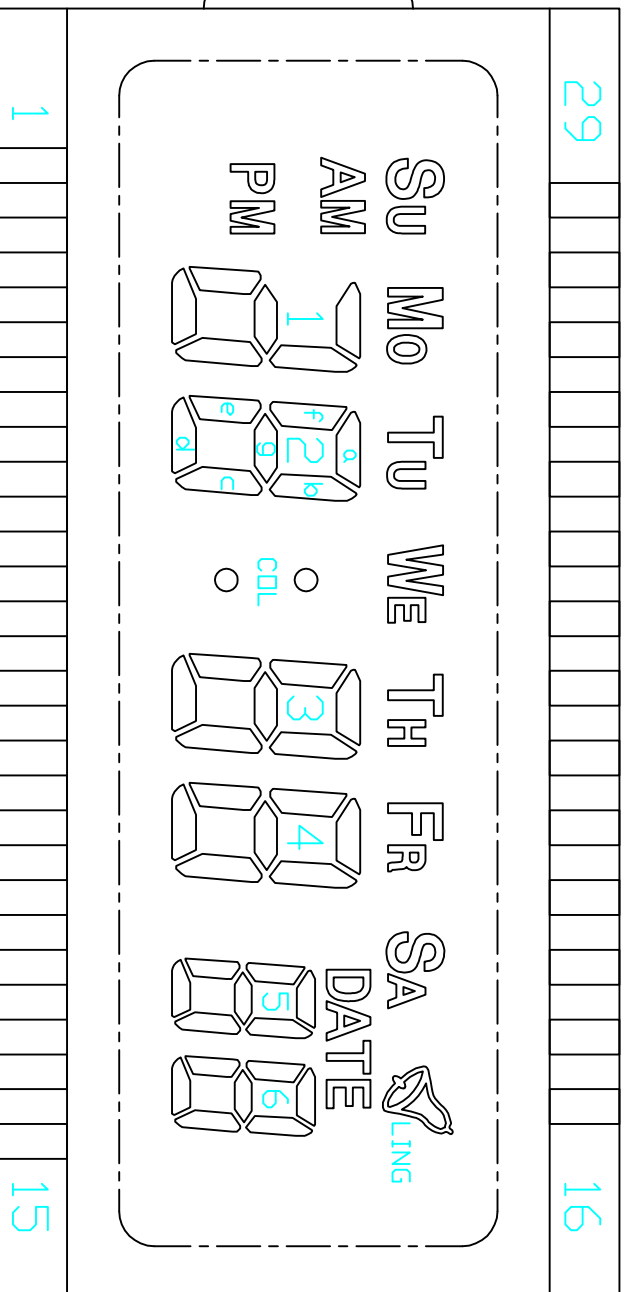

PIN	1	2	3	4	5	6	7	8	9	10	11	12	13	14	15
COM1	2f	2g	2b	3f	3g	3b	4f	4g	4b	5f	5g	5b	6f	6g	6b
COM2	2e	2d	2c	3e	3d	3c	4e	4d	4c	5e	5d	5c	6e	6d	6c
PIN	16	17	18	19	20	21	22	23	24	25	26	27	28	29	
COM1	com1	DATE	6a	5a	4a	--	3a	--	COL	2a	1c	ade	PM	--	
COM2	--	LING	SA	FR	TH	--	WE	--	TU	MO	1b	SU	AM	com2	





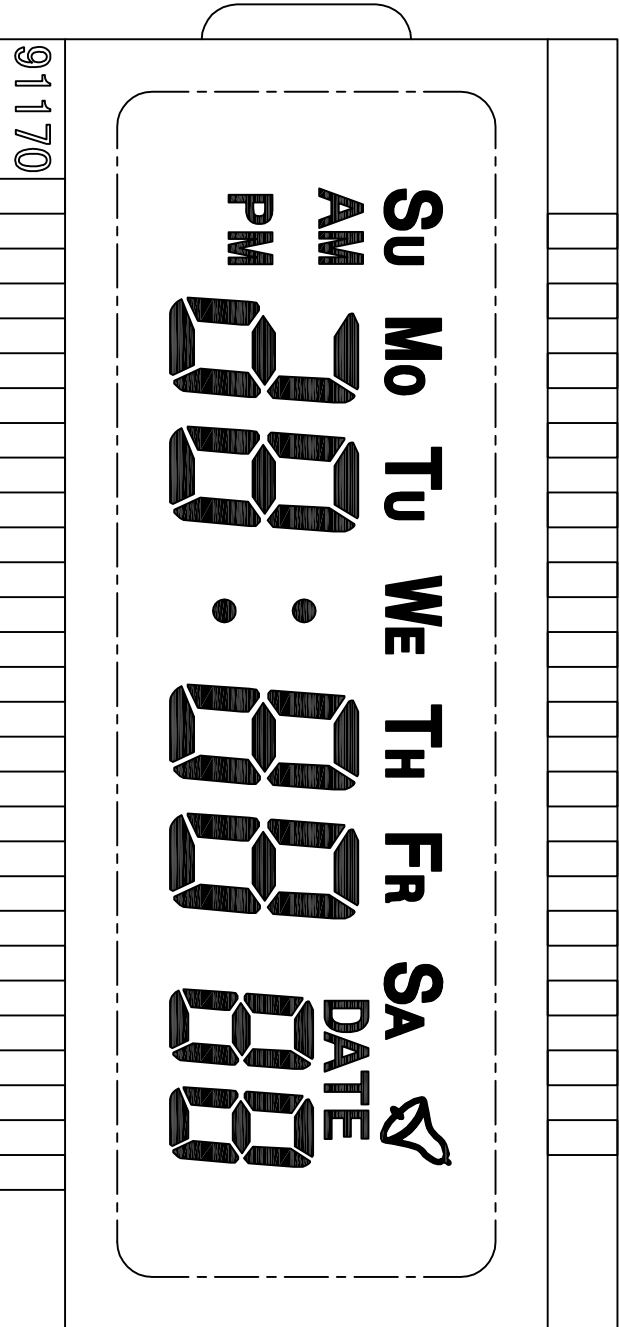

请仔细核对逻辑!

DRAWN BY :		WINCOM	
CHECKED BY :		WINCOM TECH CO.,LTD	
TEL: (0755)26154265		UNITS	
FAX: (0755)83308659		MM	
jjangyao@wincomltd.com		TITL	
DWG NO.: TP093		SHEET: 2/3	
REV: A		SCALE:	

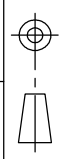
REV.	DESCRIPTION OF MODIFY	DATE
A	First Drawing	2007.11.21
B	Add Pintable	2007.11.24
C	Remove Null Pin 19	2007.11.26



显示效果图

DRAWN BY :		WINCOM		WINCOM TECH CO.,LTD			
CHECKED BY :		WINCOM		WINCOM			
TEL: (0755)26154265		WINCOM		WINCOM			
FAX: (0755)83308659		WINCOM		WINCOM			
jjangyao@wincomlcd.com		WINCOM		WINCOM			
DWG NO.: TP093		REV: A		SHEET: 3/3			
SIZE:		SCALE:		UNITS: MM			
				TITL		