



FEATURES:

- RoHS compliant
- 4 Pin SIP Package
- Low ripple and noise
- High efficiency up to 83%
- Operating temperature -40°C to + 85°C
- Input / Output isolation 1000 and 3000VDC
- Pin compatible with multiple manufacturers

Models
Single output



Model	Input Voltage (V)	Output Voltage (V)	Output Current max (mA)	Isolation (VDC)	Max Capacitive Load (µF)	Input Current Full Load No Load (mA)		Efficiency (%)
AM1S-0503SZ	4.5-5.5	3.3	300	1000	220	257	20	78
AM1S-0505SZ	4.5-5.5	5	200	1000	220	247	25	81
AM1S-0507SZ	4.5-5.5	7.2	140	1000	220	241	16	83
AM1S-0509SZ	4.5-5.5	9	110	1000	220	250	26	80
AM1S-0512SZ	4.5-5.5	12	83	1000	220	300	25	80
AM1S-0515SZ	4.5-5.5	15	67	1000	220	244	35	82
AM1S-0518SZ	4.5-5.5	18	56	1000	220	247	25	81
AM1S-0524SZ	4.5-5.5	24	42	1000	220	289	35	83
AM1S-1203SZ	10.8-13.2	3.3	300	1000	220	107	15	78
AM1S-1205SZ	10.8-13.2	5	200	1000	220	105	16	79
AM1S-1207SZ	10.8-13.2	7.2	140	1000	220	100	16	83
AM1S-1209SZ	10.8-13.2	9	110	1000	220	107	15	78
AM1S-1212SZ	10.8-13.2	12	83	1000	220	125	15	80
AM1S-1215SZ	10.8-13.2	15	67	1000	220	105	15	79
AM1S-1218SZ	10.8-13.2	18	56	1000	220	104	20	80
AM1S-1224SZ	10.8-13.2	24	42	1000	220	123	25	81
AM1S-2403SZ	21.6-26.4	3.3	300	1000	220	54	8	77
AM1S-2405SZ	21.6-26.4	5	200	1000	220	52	8	80
AM1S-2407SZ	21.6-26.4	7.2	140	1000	220	54	10	77
AM1S-2409SZ	21.6-26.4	9	110	1000	220	54	7	77
AM1S-2412SZ	21.6-26.4	12	83	1000	220	62	8	80
AM1S-2415SZ	21.6-26.4	15	67	1000	220	51	8	81
AM1S-2418SZ	21.6-26.4	18	56	1000	220	52	8	80
AM1S-2424SZ	21.6-26.4	24	42	1000	220	60	9	83
AM1S-4803SZ	43.2-52.8	3.3	300	1000	220	29	6	73
AM1S-4805SZ	43.2-52.8	5	200	1000	220	28	6	74
AM1S-4807SZ	43.2-52.8	7.2	140	1000	220	27	7	77
AM1S-4809SZ	43.2-52.8	9	110	1000	220	27	5	78
AM1S-4812SZ	43.2-52.8	12	83	1000	220	32	5	77
AM1S-4815SZ	43.2-52.8	15	67	1000	220	27	5	76
AM1S-4818SZ	43.2-52.8	18	56	1000	220	28	8	75
AM1S-4824SZ	43.2-52.8	24	42	1000	220	31	8	80
AM1S-0503SH30Z	4.5-5.5	3.3	300	3000	220	257	20	80
AM1S-0505SH30Z	4.5-5.5	5	200	3000	220	247	25	82
AM1S-0507SH30Z	4.5-5.5	7.2	140	3000	220	241	16	81
AM1S-0509SH30Z	4.5-5.5	9	110	3000	220	250	26	83
AM1S-0512SH30Z	4.5-5.5	12	83	3000	220	300	25	78
AM1S-0515SH30Z	4.5-5.5	15	67	3000	220	244	35	79
AM1S-0518SH30Z	4.5-5.5	18	56	3000	220	247	25	83
AM1S-0524SH30Z	4.5-5.5	24	42	3000	220	289	35	78
AM1S-1203SH30Z	10.8-13.2	3.3	300	3000	220	107	15	80
AM1S-1205SH30Z	10.8-13.2	5	200	3000	220	105	16	79
AM1S-1207SH30Z	10.8-13.2	7.2	140	3000	220	100	16	80
AM1S-1209SH30Z	10.8-13.2	9	110	3000	220	107	15	81
AM1S-1212SH30Z	10.8-13.2	12	83	3000	220	125	15	80
AM1S-1215SH30Z	10.8-13.2	15	67	3000	220	105	15	82
AM1S-1218SH30Z	10.8-13.2	18	56	3000	220	104	20	81
AM1S-1224SH30Z	10.8-13.2	24	42	3000	220	123	25	83

Models

Single output (continued)

Model	Input Voltage (V)	Output Voltage (V)	Output Current max (mA)	Isolation (VDC)	Max Capacitive Load (µF)	Input Current Full Load No Load (mA)		Efficiency (%)
AM1S-2403SH30Z	21.6-26.4	3.3	300	3000	220	54	8	80
AM1S-2405SH30Z	21.6-26.4	5	200	3000	220	52	8	81
AM1S-2407SH30Z	21.6-26.4	7.2	140	3000	220	54	10	80
AM1S-2409SH30Z	21.6-26.4	9	110	3000	220	54	7	83
AM1S-2412SH30Z	21.6-26.4	12	83	3000	220	62	8	73
AM1S-2415SH30Z	21.6-26.4	15	67	3000	220	51	8	74
AM1S-2418SH30Z	21.6-26.4	18	56	3000	220	52	8	77
AM1S-2424SH30Z	21.6-26.4	24	42	3000	220	60	9	78
AM1S-4803SH30Z	43.2-52.8	3.3	300	3000	220	29	6	77
AM1S-4805SH30Z	43.2-52.8	5	200	3000	220	28	6	76
AM1S-4807SH30Z	43.2-52.8	7.2	140	3000	220	27	7	75
AM1S-4809SH30Z	43.2-52.8	9	110	3000	220	27	5	80
AM1S-4812SH30Z	43.2-52.8	12	83	3000	220	32	5	80
AM1S-4815SH30Z	43.2-52.8	15	67	3000	220	27	5	81
AM1S-4818SH30Z	43.2-52.8	18	56	3000	220	28	8	80
AM1S-4824SH30Z	43.2-52.8	24	42	3000	220	31	8	83

Input Specifications

Parameters	Nominal	Typical	Maximum	Units
Voltage range	5	4.5-5.5		VDC
	12	10.8-13.2		
	24	21.6-26.4		
	48	43.2-52.8		
Filter	Capacitor			
Turn on Transient process time			25	ms
Start up time		200		ms
Absolute Maximum Rating	5 Vin	0-7		VDC
	12 Vin	0-15		
	24 Vin	0-28		
	48 Vin	0-54		
Peak Input Voltage time		100		ms

Isolation Specifications

Parameters	Conditions	Typical	Rated	Units
Tested I/O voltage	60sec		1000 and 3000	VDC
Resistance		> 1000		MOhm
Capacitance		60		pF

Output Specifications

Parameters	Conditions	Typical	Maximum	Units
Voltage accuracy		±3		%
Short Circuit protection		Momentary (1 sec)		
Line voltage regulation (Single)	For 1% change of Vin	±1.2		% of Vin
Load voltage regulation (Single)	Load 20 – 100%	±10		%
Load voltage regulation (Single) 3.3V output model	Load 20 – 100%	±20		%
Temperature coefficient		±0.02		%/°C
Ripple & Noise	At 20MHz Bandwidth	100		mV p-p
Capacitive load			220	µF
Rising time		50		ms

General Specifications

Parameters	Conditions	Typical	Maximum	Units
Switching frequency	100% load	80		KHz
Operating temperature	Full Load without Derating	-40to +85		°C
Storage temperature		-55 to +125		°C
Max Case temperature			100	°C
Cooling	Free air convection			
Humidity			95	%
Case material	Non-conductive black plastic UL94-VO			
Weight		1.8		g
Dimensions (L x W x H)	0.46 x 0.24 x 0.38 inches		11.68 x 6.00 x 9.65 mm	
MTBF	>1 191 000 hrs(MIL-HDBK -217F, Ground Benign, t=+25°C)			

NOTE: All specifications are measured at an ambient temperature of 25°C, humidity<75%, nominal input voltage and at rated output load unless otherwise specified.

Safety Specifications

Standards

Agency approvals	CE
Safety	EN55022 (Radiated Emissions) class B
	EN55024 (Noise Immunity), IEC61000-4-2(ESD)
	IEC61000-4-3(Radiated immunity)

Pin Out SpecificationsDimensions

Pin	Single
1	- V Input
2	+V Input
3	- V Output
4	+V Output

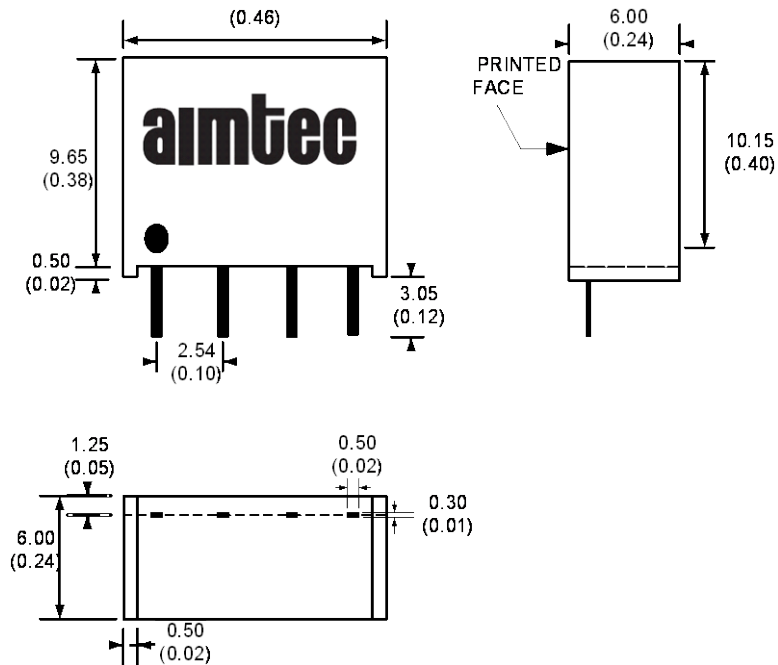

Input Reflected Ripple Test Circuit

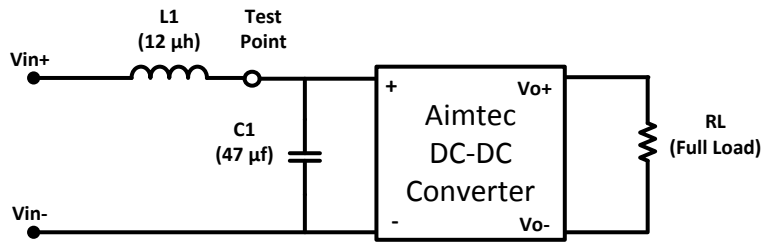

* Tested at full load, and nominal input

EMI Filtering

To meet conducted emissions the following circuit is recommended with the external components as noted in the table below.

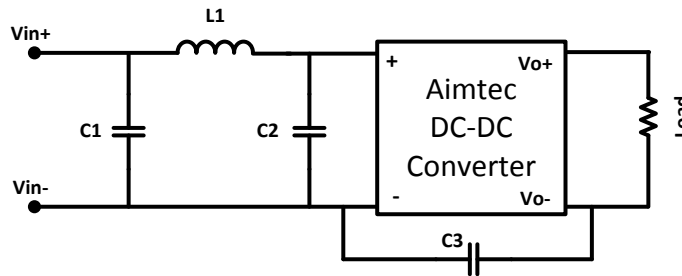

Model	C1	L1	C2	C3
5Vin	2.2 µF / 100V	18 µH		
12 Vin	2.2 µF / 100V	18 µH		
24 Vin	2.2 µF / 100V	18 µH	2.2 µF / 100V	470pF / 2KV
48 Vin	10 µF / 100V*	18 µH	2.2 µF / 100V	470pF / 2KV

* - Electrolytic Capacitor Type

Additionally in order to meet IEC 61000-4-4 and 61000-4-5 and external capacitor is recommended (ex. Nippon KY series of size 470µF / 100V).

Typical Efficiency Chart Examples

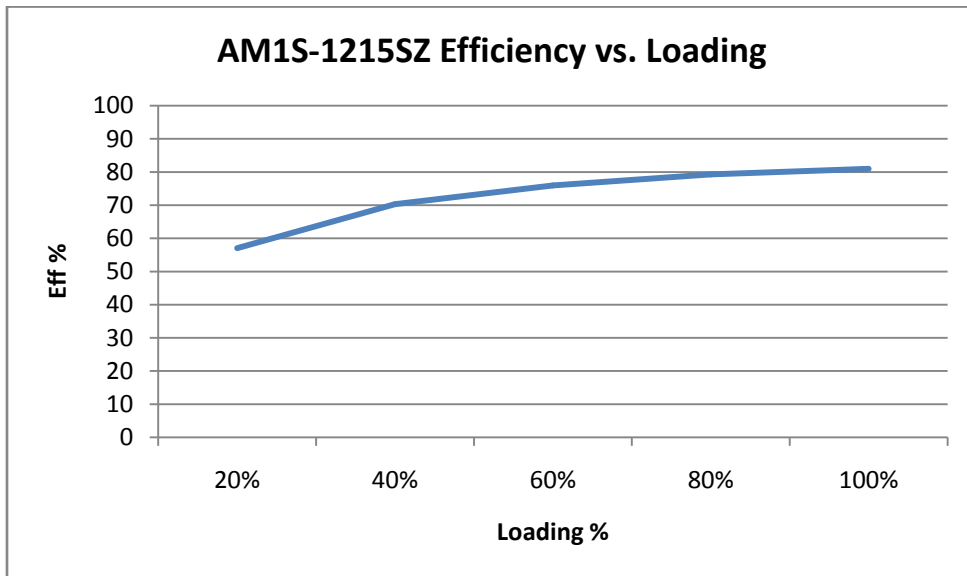
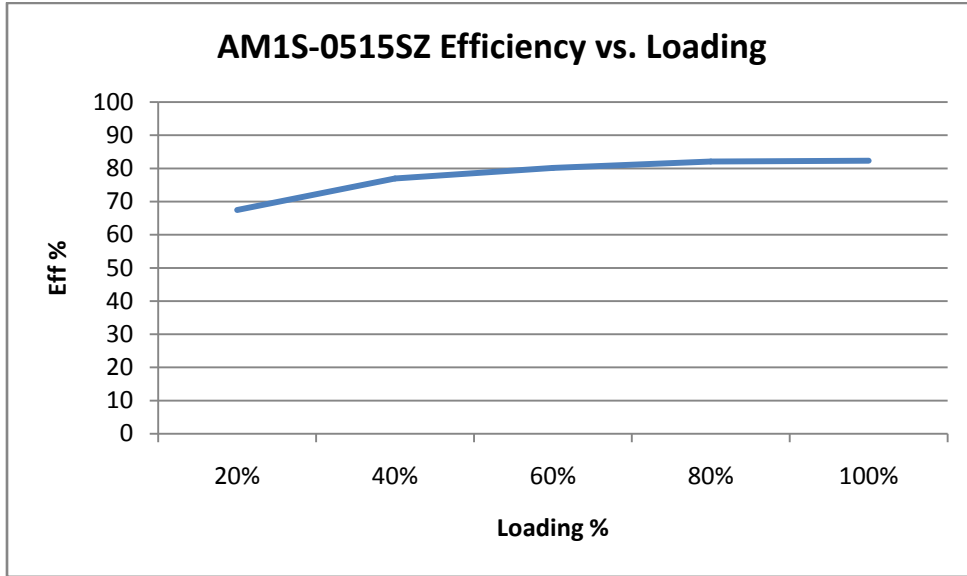

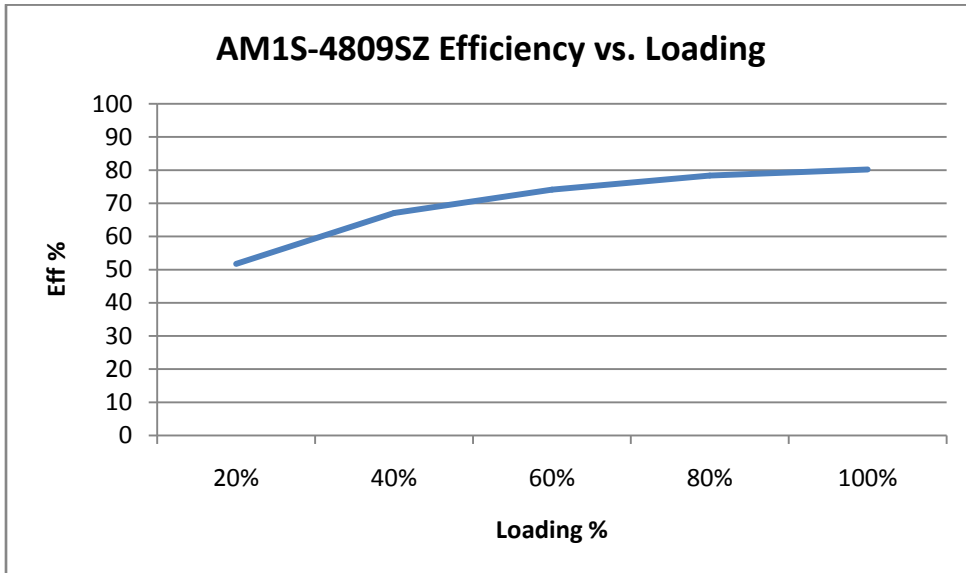
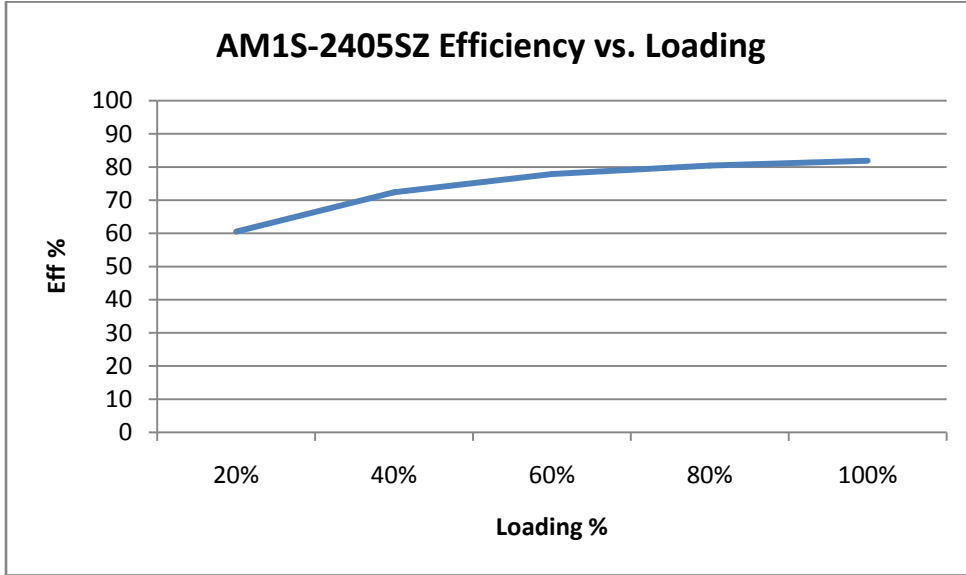

NOTE: **1.** Datasheets are updated as needed and as such, specifications are subject to change without notice. Once printed or downloaded, datasheets are no longer controlled by Aimtec; refer to www.aimtec.com for the most current product specifications. **2.** Product labels shown, including safety agency certifications on labels, may vary based on the date manufactured. **3.** Mechanical drawings and specifications are for reference only. **4.** All specifications are measured at an ambient temperature of 25°C, humidity < 75%, nominal input voltage and at rated output load unless otherwise specified. **5.** Aimtec may not have conducted destructive testing or chemical analysis on all internal components and chemicals at the time of publishing this document. CAS numbers and other limited information are considered proprietary and may not be available for release. **6.** This product is not designed for use in critical life support systems, equipment used in hazardous environments, nuclear control systems or other such applications which necessitate specific safety and regulatory standards other than the ones listed in this datasheet. **7.** Warranty is in accordance with Aimtec's standard Terms of Sale available at www.aimtec.com.