



DATA SHEET

1N5348B~1N5388B

GLASS PASSIVATED JUNCTION SILICON ZENER DIODE

VOLTAGE- 11 to 200 Volts Power - 5.0 Watts

FEATURES

- Low profile package
- Built-in strain relief
- Glass passivated junction
- Low inductance
- Typical I_r less than 5.0 μ A above 11V
- Plastic package has Underwriters Laboratory Flammability Classification 94V-O
- High temperature soldering : 260°C /10 seconds at terminals

MECHANICAL DATA

Case: JEDEC DO-201AE, Molded plastic over passivated junction
 Terminals: solder platble,solderable per MIL-STD-750,Method 2026
 Standard Packing: 52mm tape
 Weight: 0.04 ounce, 1.1 gram

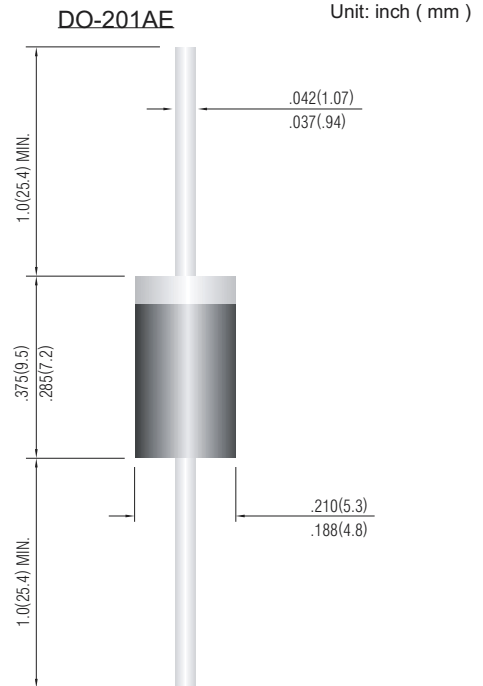

MAXIMUM RATINGS AND ELECTRICAL CHARACTERISTICS

Ratings at 25°C ambient temperature unless otherwise specified.

	SYMBOLS	VALUE	UNITS
DC Power Dissipation on $T_L=75^\circ\text{C}$,Measure at Zero Lead Length Derate above 75°C (NOTE 1)	P_D	5.0 40.0	Watts mW / °C
Peak Forward Surge Current 8.3ms single half sine-wave superimposed on rated load (JEDEC method)	I_{FSM}	See Fig. 5	Amps
Operating and Storage Temperature Range	T_J, T_{STG}	-55 to +150	°C

NOTES:

- 1.Mounted on 8.0mm² copper pads to each terminal.
- 2.8.3ms single half sine-wave ,or equivalent square wave ,duty cycle=4 pulses per minute maximum.



Part Number	V _Z @ I _{ZT}	I _{ZT}	Maximum Zener Impedance			Leakage Current		Maximum Zener Current I _{ZM}	Surge Current @ Ta=25°C	Max Voltage Regulation V _Z	PACKAGE
			Z _{ZT} @ I _{ZT}	Z _{ZK} @ I _{ZK}	I _{ZK}	I _R	V _R				
	V	mA	Ohms	Ohms	mA	uA Max	V	mA	ir-mA	V	
5.0 Watt ZENER											
1N5348B	11	125	2.5	125	1.0	5.0	8.4	430	8.0	0.25	DO-201AE
1N5349B	12	100	2.5	125	1.0	2.0	9.1	395	7.5	0.25	DO-201AE
1N5350B	13	100	2.5	100	1.0	1.0	9.9	365	7.0	0.25	DO-201AE
1N5351B	14	100	2.5	75	1.0	1.0	10.6	340	6.7	0.25	DO-201AE
1N5352B	15	75	2.5	75	1.0	1.0	11.5	31	6.3	0.25	DO-201AE
1N5353B	16	75	2.5	75	1.0	1.0	12.2	295	6.0	0.3	DO-201AE
1N5354B	17	70	2.5	75	1.0	0.5	12.9	280	5.8	0.35	DO-201AE
1N5355B	18	65	2.5	75	1.0	0.5	13.7	265	5.5	0.4	DO-201AE
1N5356B	19	65	3.0	75	1.0	0.5	14.4	250	5.3	0.4	DO-201AE
1N5357B	20	65	3.0	75	1.0	0.5	15.2	237	5.1	0.4	DO-201AE
1N5358B	22	50	3.5	75	1.0	0.5	16.7	216	4.7	0.45	DO-201AE
1N5359B	24	50	3.5	100	1.0	0.5	18.2	198	4.4	0.55	DO-201AE
1N5360B	25	50	4.0	110	1.0	0.5	19.0	190	4.3	0.55	DO-201AE
1N5361B	27	50	5.0	120	1.0	0.5	20.6	176	4.1	0.6	DO-201AE
1N5362B	28	50	6.0	130	1.0	0.5	21.2	170	3.9	0.6	DO-201AE
1N5363B	30	40	8.0	140	1.0	0.5	22.8	158	3.7	0.6	DO-201AE
1N5364B	33	40	10	150	1.0	0.5	25.1	144	3.5	0.6	DO-201AE
1N5365B	36	30	11	160	1.0	0.5	27.4	132	3.3	0.65	DO-201AE
1N5366B	39	30	14	170	1.0	0.5	29.7	122	3.1	0.65	DO-201AE
1N5367B	43	30	20	190	1.0	0.5	32.7	110	2.8	0.7	DO-201AE
1N5368B	47	25	25	210	1.0	0.5	35.8	100	2.7	0.8	DO-201AE
1N5369B	51	25	27	230	1.0	0.5	38.8	93	2.5	0.9	DO-201AE
1N5370B	56	20	35	280	1.0	0.5	42.6	86	2.3	1.0	DO-201AE
1N5371B	60	20	40	350	1.0	0.5	45.5	79	2.2	1.2	DO-201AE
1N5372B	62	20	42	400	1.0	0.5	47.1	76	2.1	1.35	DO-201AE
1N5373B	68	20	44	500	1.0	0.5	51.7	70	2.0	1.5	DO-201AE
1N5374B	75	20	45	620	1.0	0.5	56.0	63	1.9	1.6	DO-201AE
1N5375B	82	15	65	720	1.0	0.5	62.2	58	1.8	1.8	DO-201AE
1N5376B	87	15	75	760	1.0	0.5	66.0	54.5	1.7	2.0	DO-201AE
1N5377B	91	15	75	760	1.0	0.5	69.2	52.5	1.6	2.2	DO-201AE
1N5378B	100	12	90	800	1.0	0.5	76.0	47.5	1.5	2.5	DO-201AE
1N5379B	110	12	125	1000	1.0	0.5	83.6	43.0	1.4	2.5	DO-201AE
1N5380B	120	10	170	1150	1.0	0.5	91.2	39.5	1.3	2.5	DO-201AE
1N5381B	130	10	190	1250	1.0	0.5	98.8	36.6	1.2	2.5	DO-201AE
1N5382B	140	8.0	230	1500	1.0	0.5	106.0	34.0	1.2	2.5	DO-201AE
1N5383B	150	8.0	330	1500	1.0	0.5	114	31.6	1.1	3.0	DO-201AE
1N5384B	160	8.0	350	1650	1.0	0.5	122	29.4	1.1	3.0	DO-201AE
1N5385B	170	8.0	380	1750	1.0	0.5	129	28.0	1.0	3.0	DO-201AE
1N5386B	180	5.0	430	1750	1.0	0.5	137	26.4	1.0	4.0	DO-201AE
1N5387B	190	5.0	450	1850	1.0	0.5	144	25.0	0.9	5.0	DO-201AE
1N5388B	200	5.0	480	1850	1.0	0.5	152	23.6	0.9	5.0	DO-201AE



RATING AND CHARACTERISTIC CURVES

TEMPERATURE COEFFICIENTS

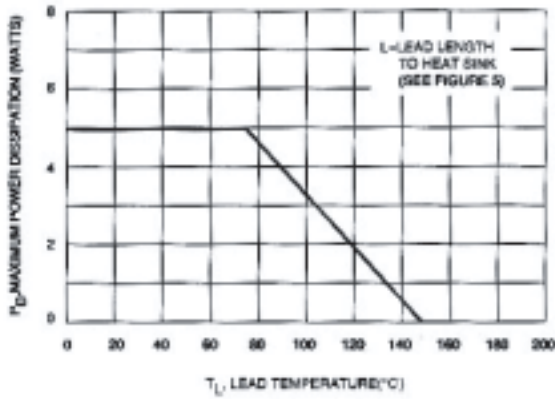

Figure 1. Power Temperature Derating Curve

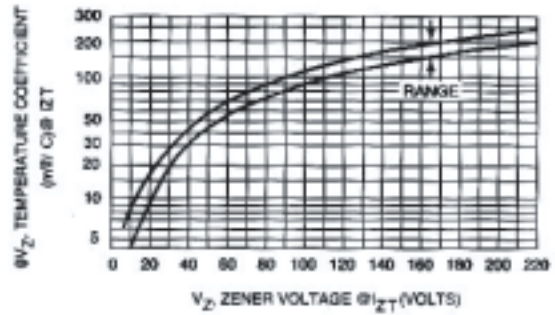

Figure 2. Temperature Coefficient-Range for Units 6 to 220 Volts

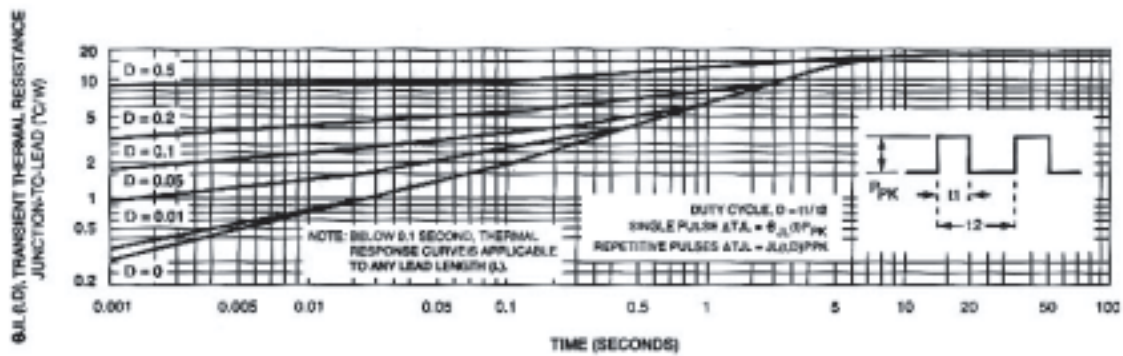

Figure 3. Typical Thermal Response

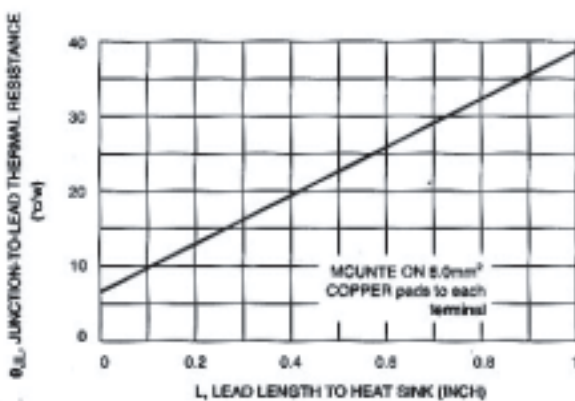

Figure 4. Typical Thermal Resistance

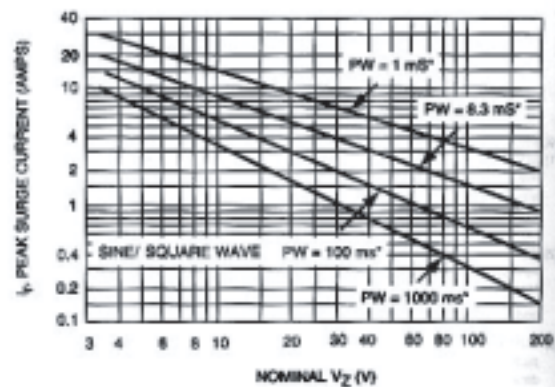

Figure 5. Maximum Non-Repetitive Surge Current versus Nominal Zener Voltage (See Note 3)

Data of Figure 3 should not be used to compute surge capability. Surge limitations are given in Figure 5. They are lower than would be expected by considering only junction temperature, as current crowding effects cause

temperatures to be extremely high in small spots resulting in device degradation should the limits of Figure 5 be exceeded.



RATING AND CHARACTERISTIC CURVES

ZENER VOLTAGE versus ZENER CURRENT
(Figures 7,8 and 9)

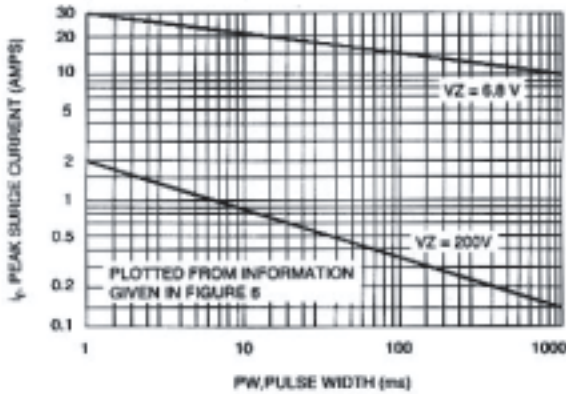

Figure 6. Peak Surge Current versus Pulse Width
(See Note 3)

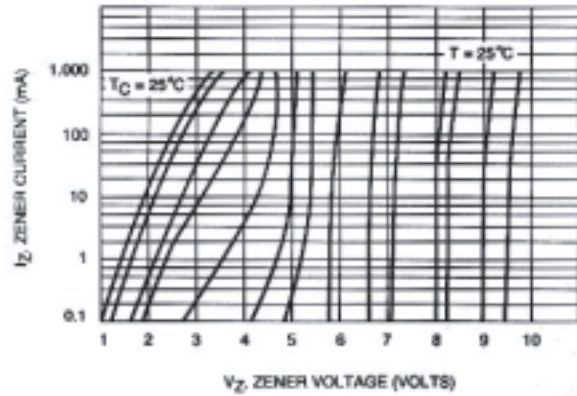

Figure 7. Zener Voltage versus Zener Current
 $V_Z = 6.8$ thru 10 Volts

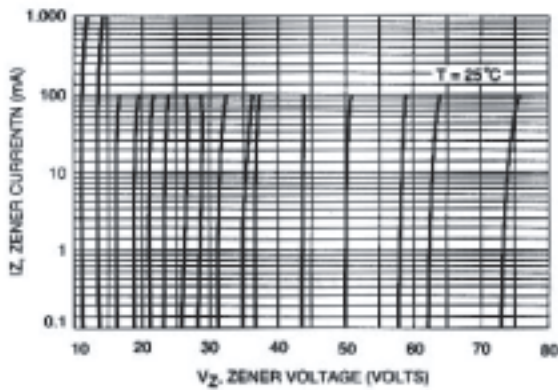

Figure 8. Zener Voltage versus Zener Current
 $V_Z = 11$ thru 75 Volts

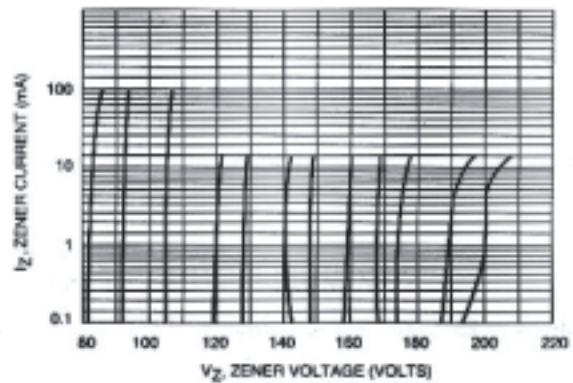

Figure 9. Zener Voltage versus Zener Current
 $V_Z = 82$ thru 200 Volts

APPLICATION NOTE

Since the actual voltage available from a given zener diode is temperature dependent, it is necessary to determine junction temperature under any set of operating conditions, in order to calculate its value. The following procedure is recommended:

Lead Temperature, T_L , should be determined from:

$$T_L = \theta_{LA} P_D + T_A$$

θ_{LA} is the lead-to-ambient thermal resistance and P_D is the power dissipation.

Junction Temperature, T_J , may be found from:

$$T_J = T_L + \Delta T_{JL}$$

ΔT_{JL} is the increase in junction temperature above the lead temperature and may be found from Figure

3 for a train of power pulses or from Figure 4 for dc power.

$$\Delta T_{JL} = \theta_{JL} P_D$$

For worst-case design, using expected limits of I_Z , limits of P_D and the extremes of T_J (ΔT_J) may be estimated. Changes in voltage, V_Z , can then be found from:

$$\Delta V = \theta_{VZ} \Delta T_J$$

θ_{VZ} , the zener voltage temperature coefficient, is found from Figures 2.

Under high power-pulse operation, the zener voltage will vary with time and may also be affected significantly by the zener resistance. For best regulation, keep current excursions as low as possible.

This datasheet has been download from:

www.datasheetcatalog.com

Datasheets for electronics components.